



HY-LAND

Timber Pack & Cutting

PROJECT Q

part

2

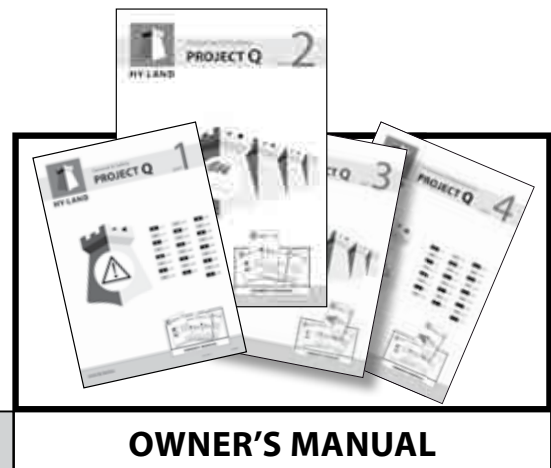
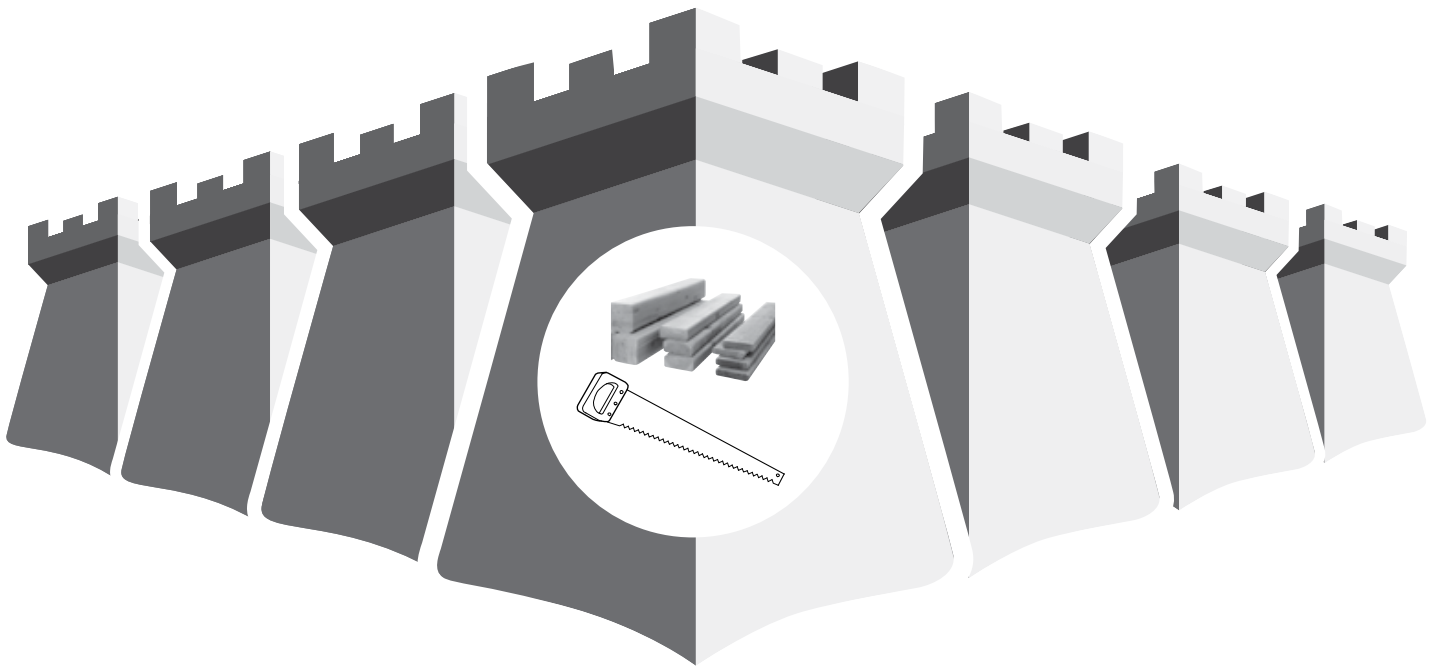

OWNER'S MANUAL

www.Hy-land.eu

part 2a

TIMBER PACK

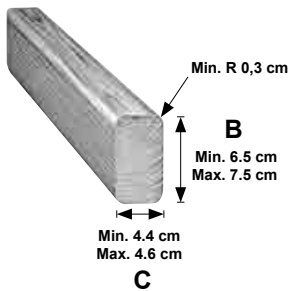
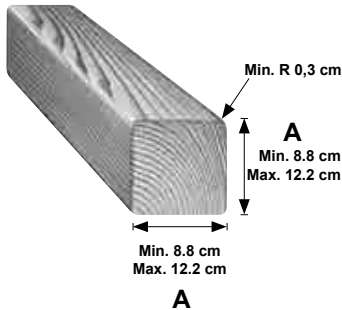

169	(169 cm)	-	4x	4x	8x
159	(159 cm)	4x	4x	6x	8x
122	(112 - 122 cm)	-	-	1x	-
80	(80 cm)	4x	4x	6x	8x
77	(70 - 77 cm)	-	-	1x	-
218	(218 cm)	5x	5x	4x	9x
214	(206 - 214 cm)	2x	2x	3x	4x
214	(206 - 214 cm)	2x	2x	3x	4x
210	(206 - 210 cm)	-	-	6x	-
178	(178 cm)	2x	2x	4x	4x
177	(162 - 177 cm)	-	3x	3x	6x
172	(156 - 172 cm)	-	3x	3x	6x
161	(159 - 161 cm)	3x	3x	6x	6x
160	(160 cm)	-	-	-	10x
157	(156,5 cm)	-	4x	4x	8x
156	(153 - 156 cm)	2x	2x	4x	4x
153	(145 - 153 cm)	2x	2x	4x	4x
146	(144 - 146 cm)	-	4x	4x	8x
144	(136 - 144 cm)	6x	6x	12x	12x
143	(142,5 cm)	-	-	2x	-
140	(140 cm)	5x	5x	8x	10x
131	(121 - 131 cm)	-	-	3x	-
126	(126 cm)	2x	2x	2x	4x
119	(118 - 119 cm)	4x	4x	6x	8x
95	(95 cm)	-	2x	2x	4x

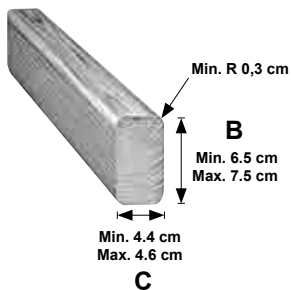

94	(93 - 95 cm)	10x	10x	16x	22x
80	(80 cm)	2x	2x	4x	6x
63	(60 - 63 cm)	7x	7x	13x	15x
48	(36 - 48 cm)	4x	4x	8x	8x

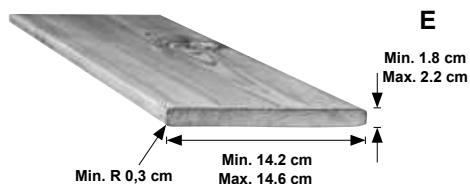

187	(171 - 187 cm)	-	4x	4x	8x
161	(160 - 161 cm)	-	2x	2x	4x
147	(145 - 147 cm)	-	2x	2x	4x
144	(136 - 144 cm)	12x	12x	24x	24x
75	(75 cm)	-	-	-	18x
48,5	(48,5 cm)	-	-	-	11x

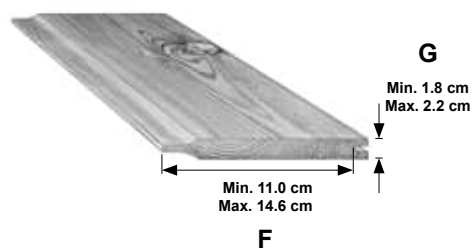

187	(171 - 187 cm)	F < 125 mm	-	28x	28x	56x
		F > 125 mm	-	24x	24x	48x
119	(118 - 119 cm)	F < 125 mm	14x	14x	28x	28x
		F > 125 mm	12x	12x	24x	24x
75	(75 cm)	35x	35x	70x	67x	

part 2b TIMBER PACK



2	3	4	5
<p>A = mm</p> <p>A1 = A × 0,536 = mm</p> <p>A2 = A × 2,07 = mm</p> <p>A3 = A × 1,97 = mm</p>	<p>B = mm</p> <p>C = mm</p>	<p>D = mm</p> <p>E = mm</p>	<p>F = mm</p> <p>G = mm</p>

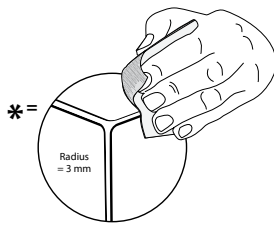
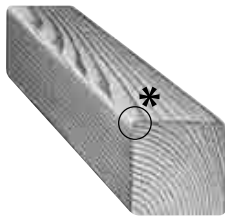

1	2	3	4
-	4x	4x	8x

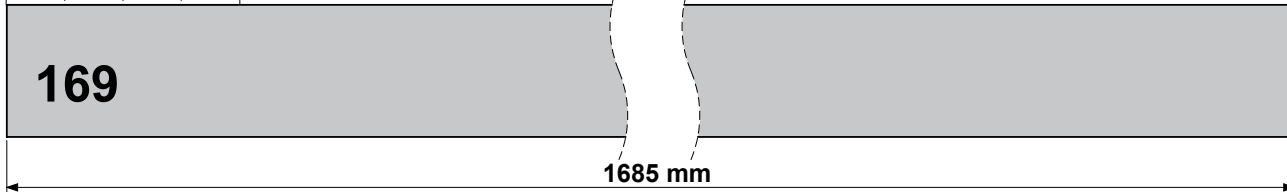

1	2	3	4
4x	4x	6x	8x

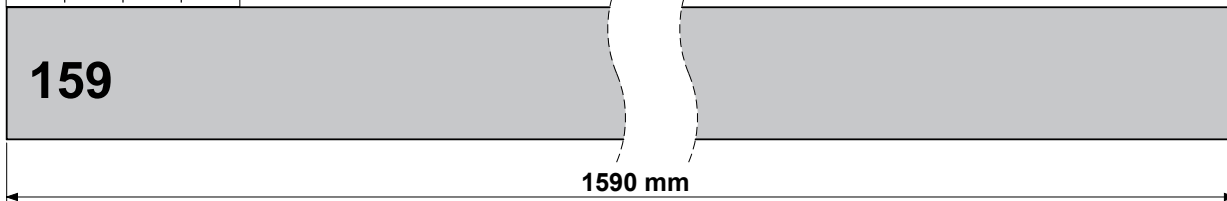

1	2	3	4
-	-	1x	-

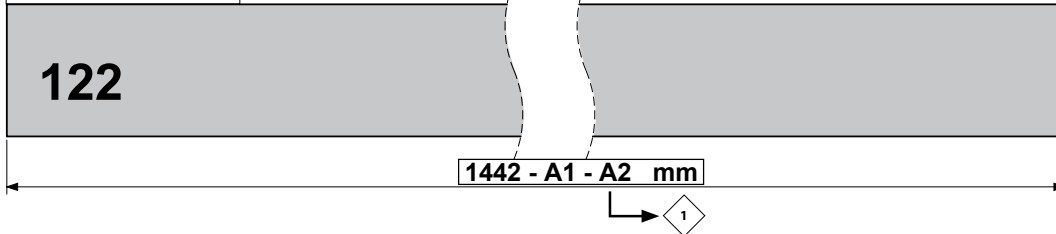

1	2	3	4
-	-	1x	-

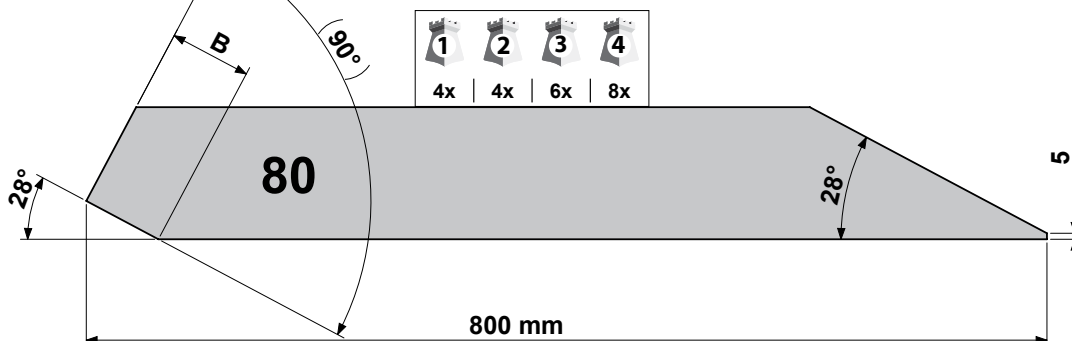
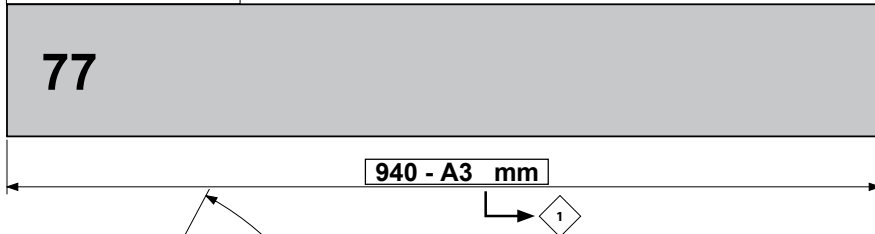

3

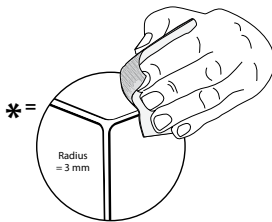
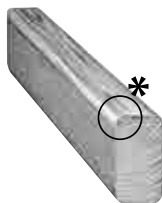

1	2	3	4
5x	5x	4x	9x

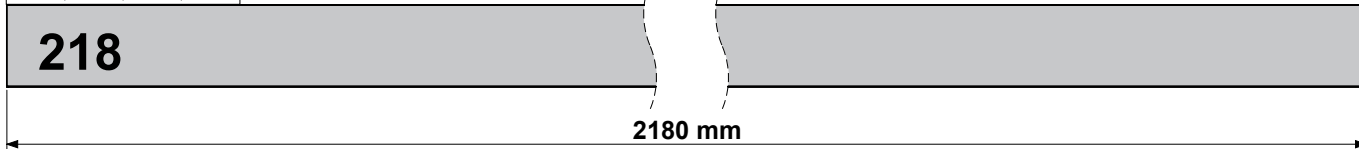

1	2	3	4
2x	2x	3x	4x

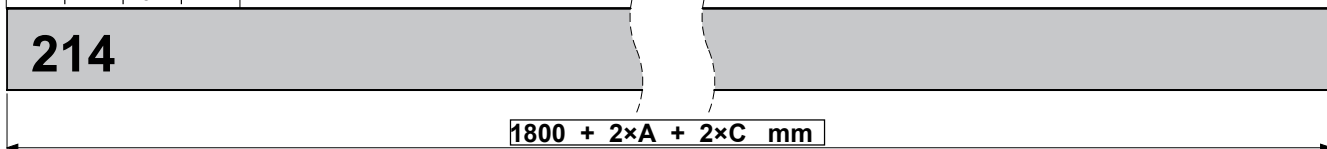

1	2	3	4
2x	2x	3x	4x

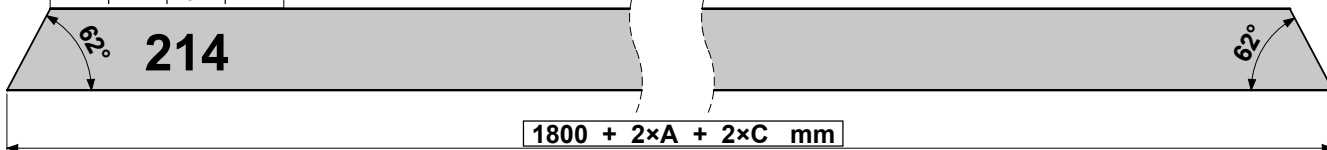

1	2	3	4
-	-	6x	-

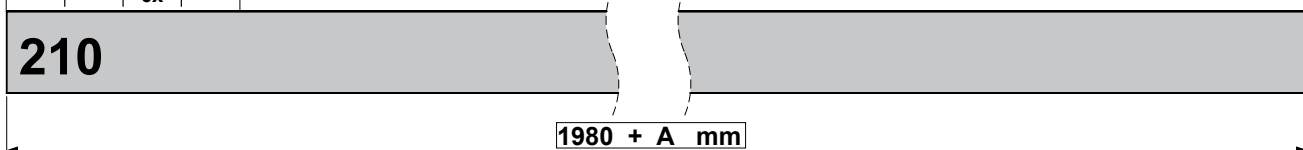

1	2	3	4
2x	2x	4x	4x

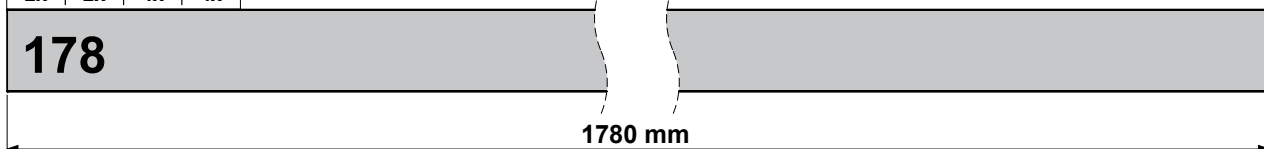

1	2	3	4
-	3x	3x	6x

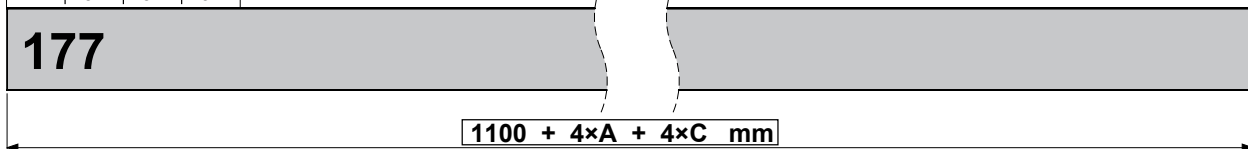

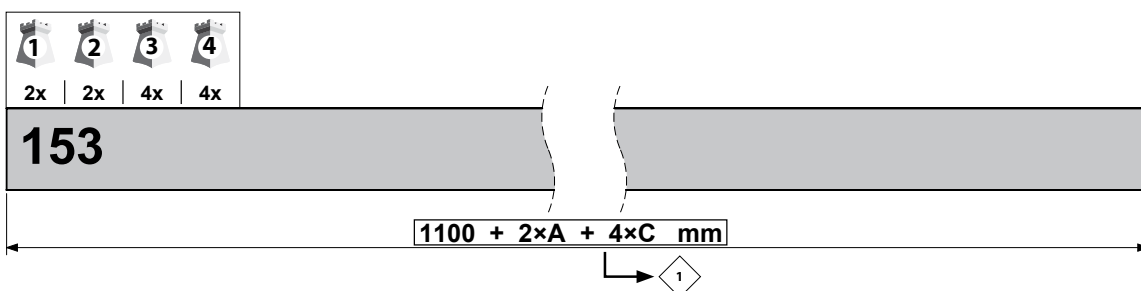
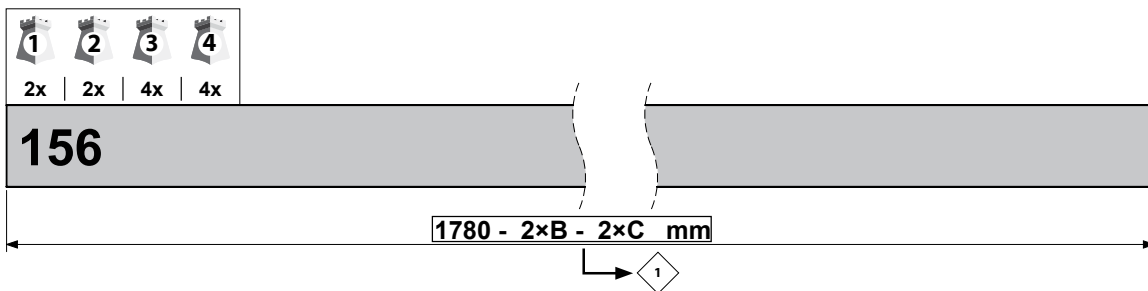
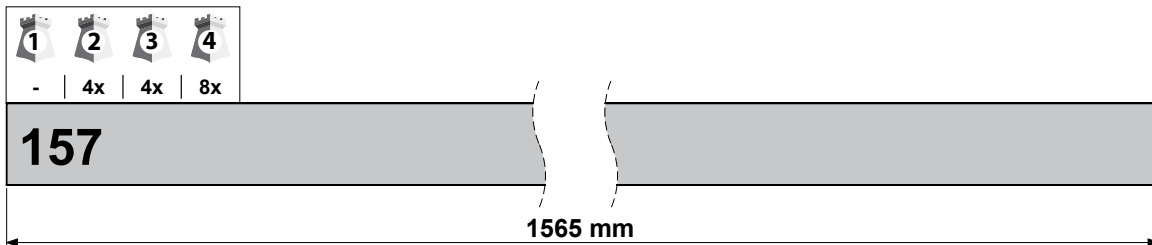
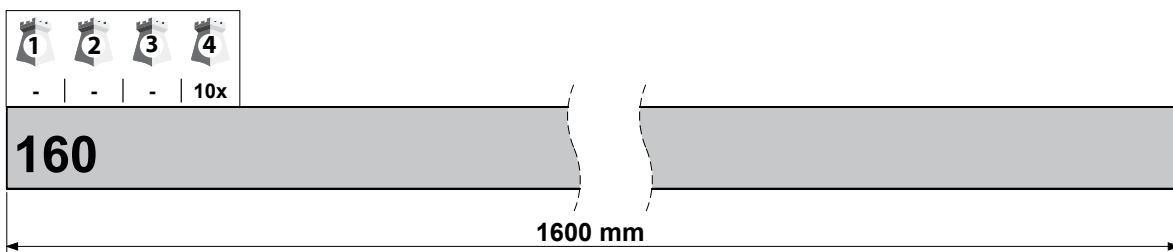
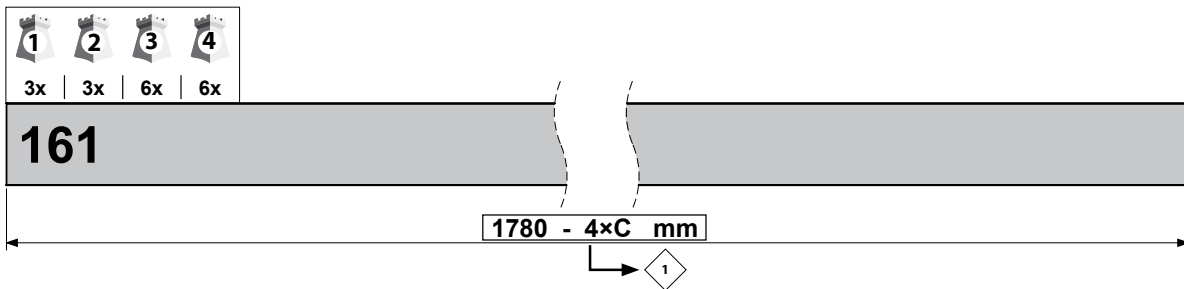
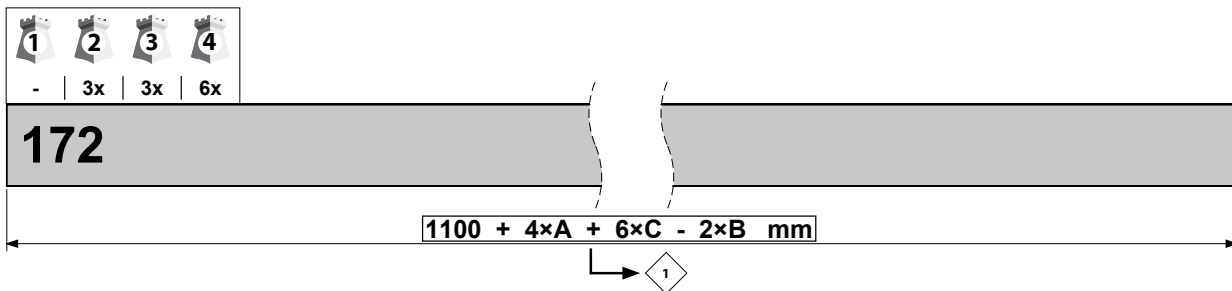

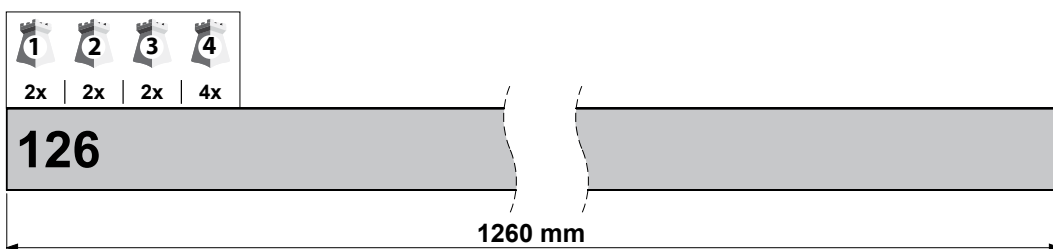
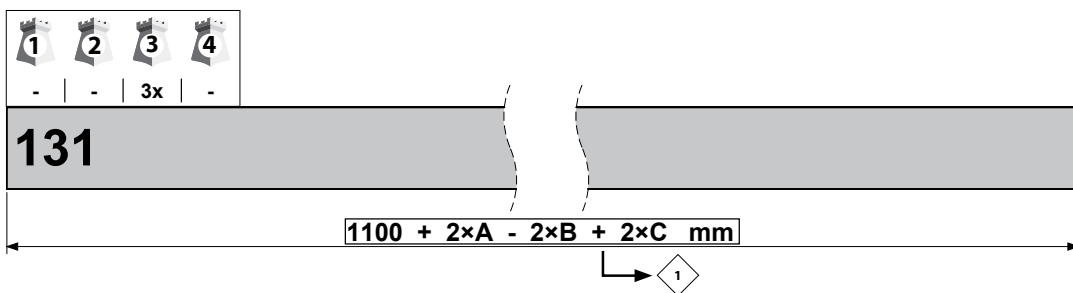
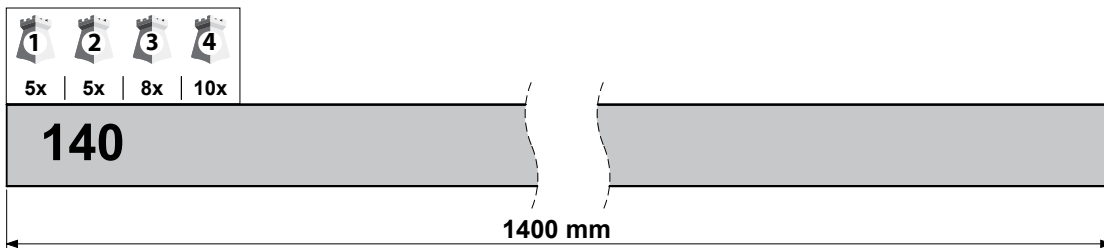
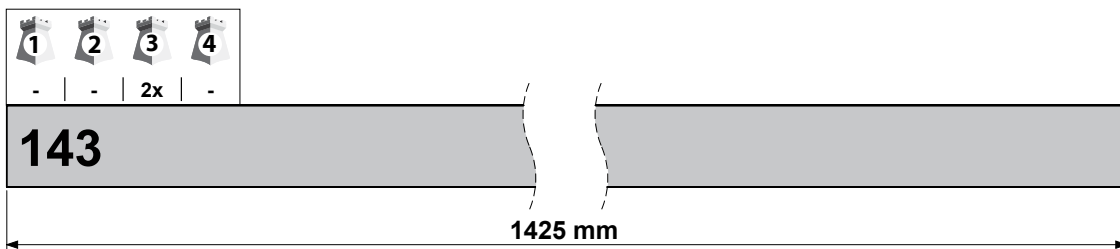
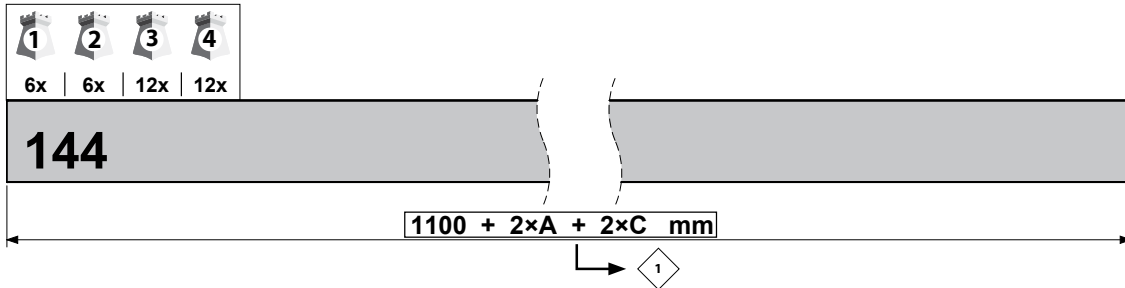
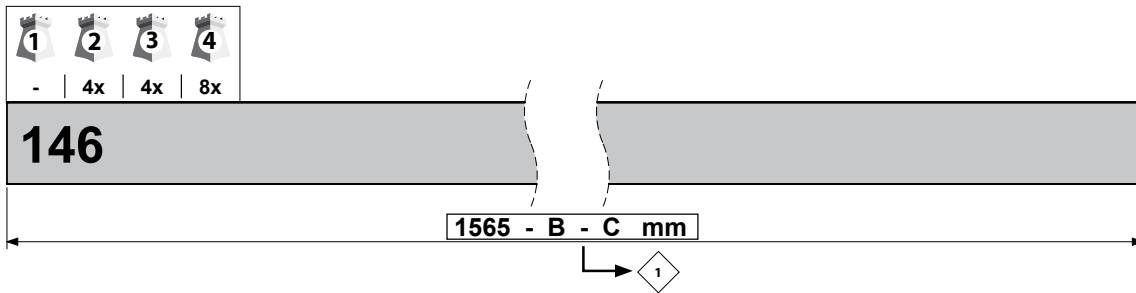

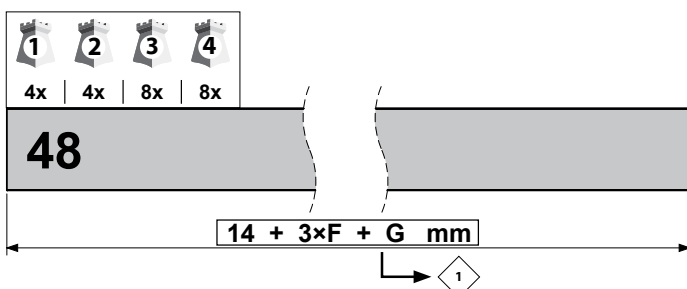
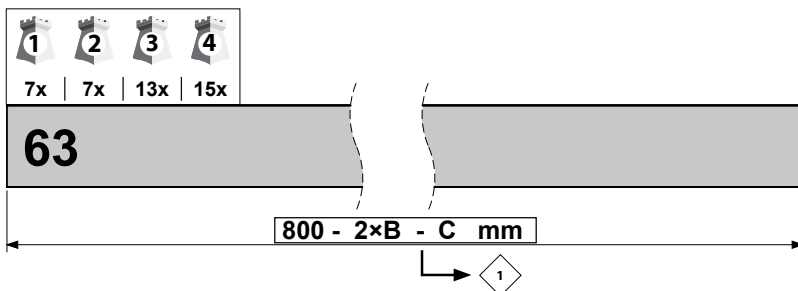
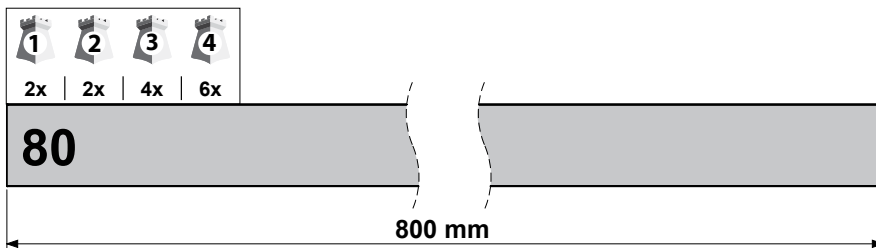
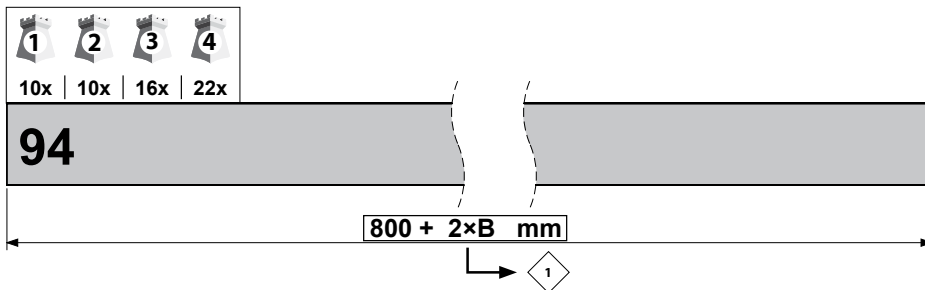
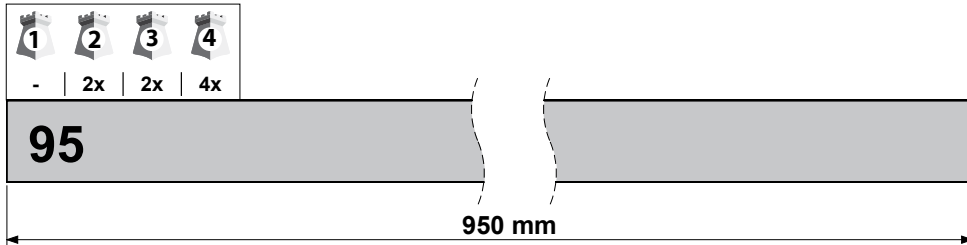
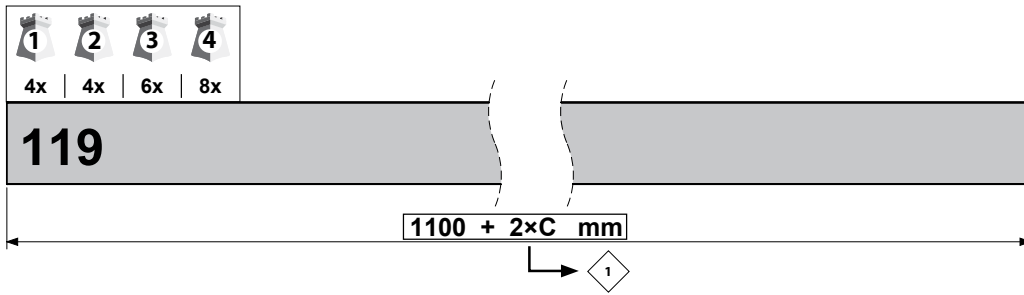

4

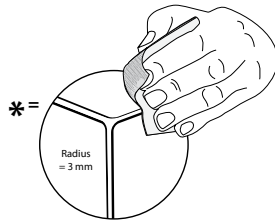

1 2 3 4
- | 4x | 4x | 8x

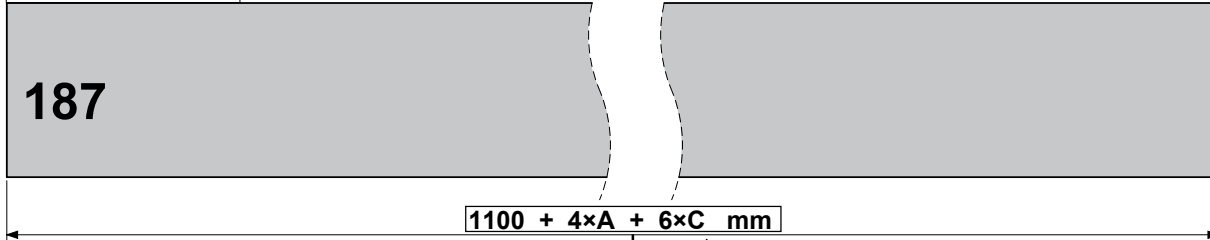

1 2 3 4
- | 2x | 2x | 4x

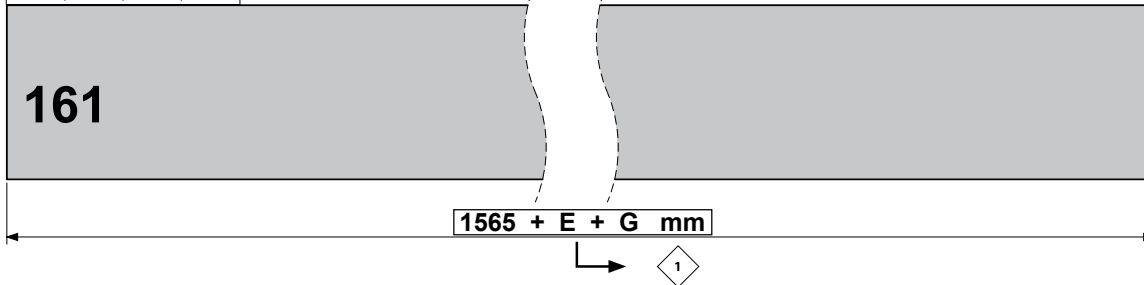

1 2 3 4
- | 2x | 2x | 4x

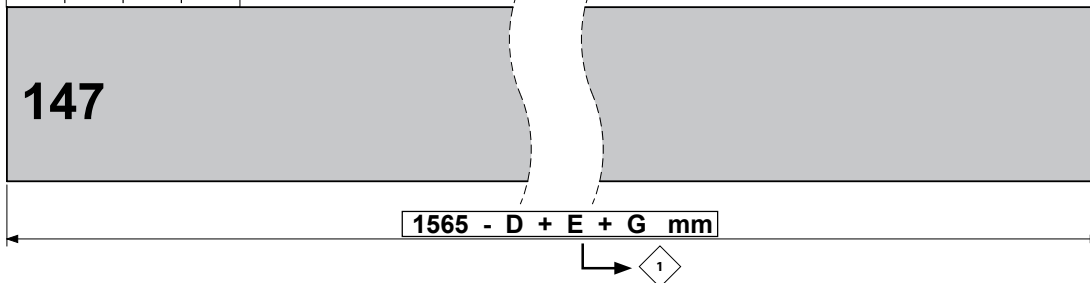

1 2 3 4
12x | 12x | 24x | 24x

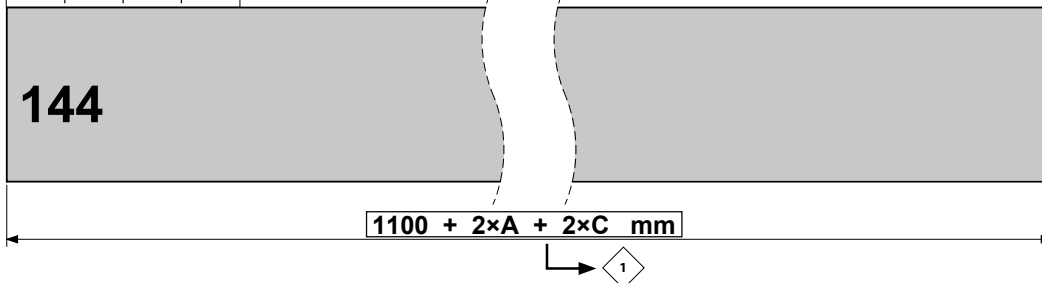

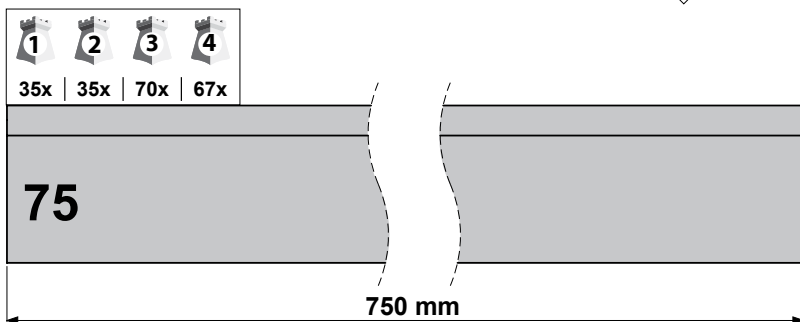
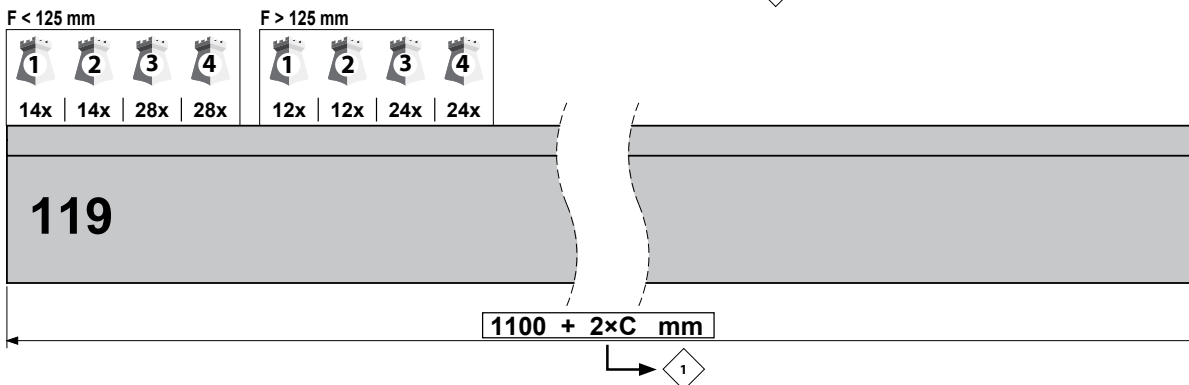
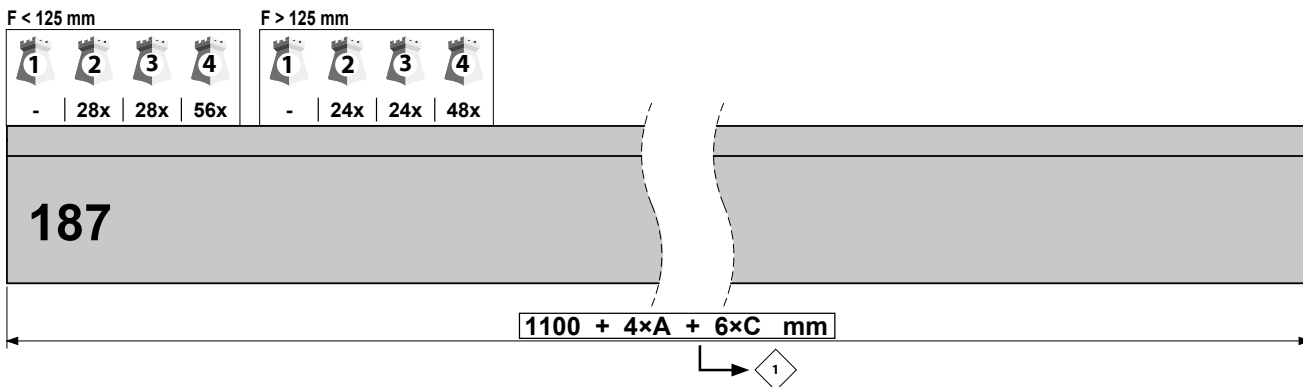
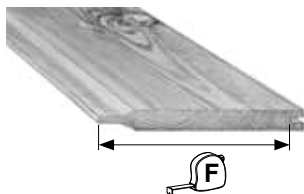
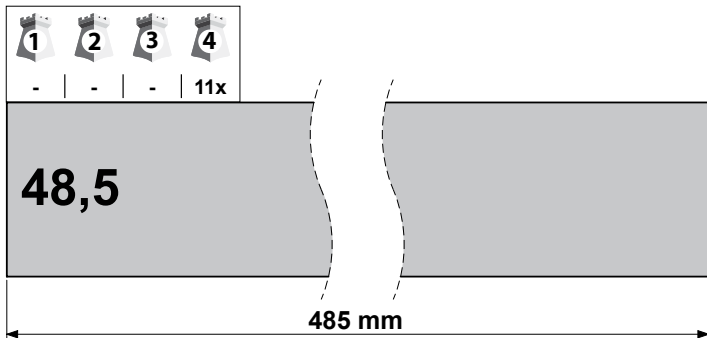
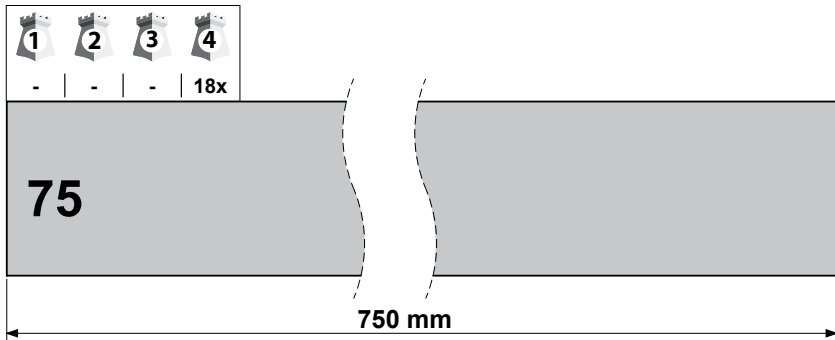

Hy-land B.V.
Valschermkade 18
NL - 1059 CD Amsterdam
The Netherlands

Tel : +31 85 44 44 101
Email : info@hy-land.eu
URL : www.hy-land.eu

Chamber of Commerce :
NL 16.078.319

www.Hy-land.eu

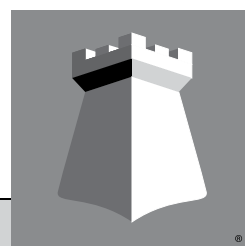

HY-LAND